

散水部断面図
φ 50~125

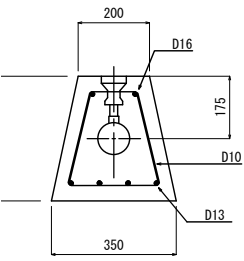

散水部断面図
φ 150

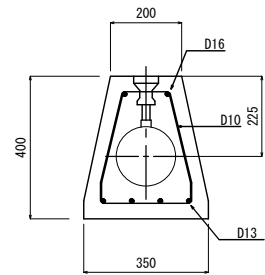

散水部断面図
φ 200

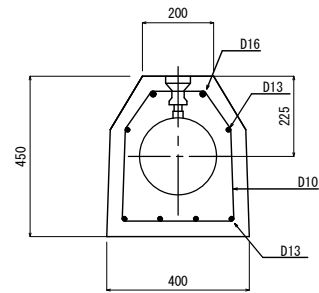

散水部断面図
φ 250

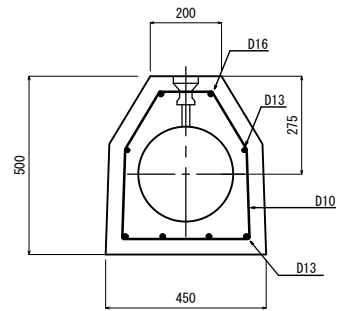

散水部断面図
横W ~ φ 100

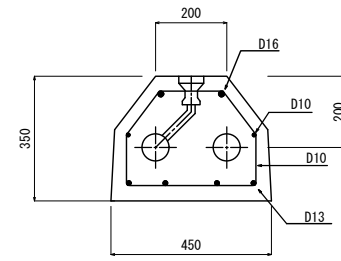

散水部断面図
横W ~ φ 125

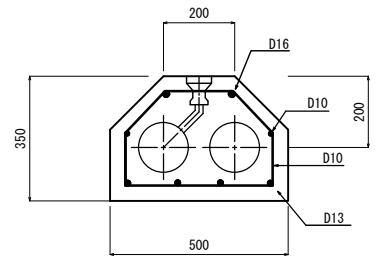

送水部断面図
φ 50~125

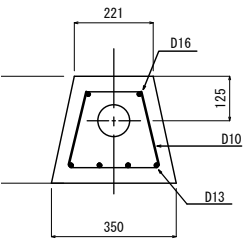

送水部断面図
φ 150

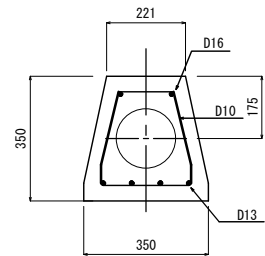

送水部断面図
φ 200

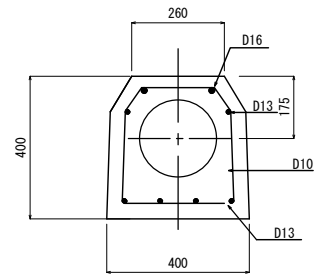

送水部断面図
φ 250

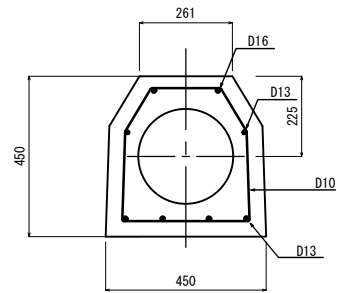

送水部断面図
横W ~ φ 100

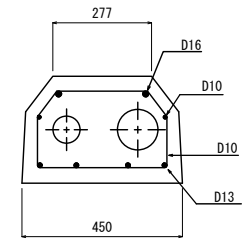

送水部断面図
横W ~ φ 125

